



STEREO TUNER PREAMPLIFIER

MX 110

CONTENTS

GENERAL DESCRIPTION	1
TECHNICAL DESCRIPTION	1
FRONT PANEL FACILITIES	5
INSTALLATION	10
CONNECTING	10
AC Connections	10
AC Power Connection	10
Input Connections	11
Output Connections	12
Antenna Connections	12
OPERATING INSTRUCTIONS	13
Balancing a Stereo System	13
Adjusting Phase	14
Balancing Loudness Between Program Sources	14
Adjusting the Balance Control After the System has been Balanced	15
Adjusting for Special Effects	15
Listening to Monophonic FM Program	15
Listening to MPX Stereo	16
Listening to a Stereo Record	16
Listening to Monophonic Records	16
Listening to Tape Decks	16
Listening to Stereo Tape Machine	17
Operating Curves	18
GUARANTEE	20



OWNER'S MANUAL

McIntosh
MX 110

MX110 TUNER PREAMPLIFIER

GENERAL DESCRIPTION

The MX110 combines in one unit an extremely low-distortion preamplifier with a highly sensitive FM multiplex stereo tuner. Every desirable feature of a tuner and a preamplifier is included in this design. Inter-station noise suppression, tuning indicator, FM multiplex indicator, individual channel bass controls, individual channel treble controls, electronic phase switch have all been engineered into the MX110. The INPUT SELECTOR gives you a choice of six different program sources. The MODE SELECTOR is a newly developed control which makes it very easy to balance a stereo system. It is designed to add left to right for monophonic operation, to control the left to right stereo perspective or to compare the left and right channels of a stereo program. The loudness of the phono channels and the auxiliary channel may be balanced to the tuner loud-

ness. These adjusting controls are located on the top of the MX110 behind the front panel. By releasing the PANLOC buttons on the front panel, you can slide the MX110 out of its mounting until the second latch engages. The top mounted LEVEL set controls are now available.

The McIntosh designed PANLOC system is the first professional installation technique to be used on stereo instruments. The PANLOC system gives you absolute ease of installation, operation, and maintenance.

The McIntosh MX110 is a beautifully engineered control center for the finest stereo sound systems. The extreme care in manufacturing, in layout design and in thermal engineering promises the usual McIntosh extra values of reliability, performance, and long life.

TECHNICAL DESCRIPTION

The radio-frequency amplifier of the MX110 is a "cascode" type circuit. The circuit is specially designed to amplify weak signals with less noise and distortion. By carefully tuning this RF amplifier during manufacturing and controlling other circuit constants, spurious response rejection is improved. The high-frequency oscillator mechanical layout is engineered for minimum response to temperature variations. In fact the combination of mechanical and electronic design is so unusually good in this circuit that automatic frequency control is not needed in the MX110. The mixer output is amplified by four flat-topped intermediate frequency amplifiers. The transformers used in the I.F. amplifiers are designed for maximum adjacent channel rejection, for electrical stability, and for electrical and mechanical resistance to shock and vibration.

The R.F. and I.F. circuits of the MX110 are completely shielded and exceed the FCC requirements for suppression of oscillator radiation. Either a 300 ohm or 75 ohm antenna may be used with the MX110. A VHF television antenna which is suitable for FM reception can be connected to the MX110.

In the MX110, a new type of mechanical tuning assembly gives smooth flywheel tuning. By controlling the relations between mass and mechanical resistance, and dividing work loads in the dial drive system, it becomes nearly impossible to detect any backlash. Yet the entire dial drive is a model of mechanical stability. For smooth, quiet action and extended life with virtually no wear, a teflon lined dial pointer carriage and nylon pulleys are used in the dial cord assembly.

MULTIPLEX DECODER

The multiplex decoder uses a special McIntosh developed detecting circuit. One of the advantages of this circuit is the elimination of the critical adjustments necessary with commonly used matrixing methods. This circuit detects the L+R sidebands and automatically matrixes the recovered information with the L+R main carrier signal. This circuit then yields the left and the right program with maximum separation.

A temperature stabilized 19KC amplifier locks-in a highly stable push-pull synchronous oscillator. Apart from other advantages, this method provides greatest noise immunity. Balanced detectors cancel 19KC and

38KC components in the output and insure low distortion.

A three-section sharp cut off filter rejects SCA interference and reduces susceptibility to spurious signals.

The MX110 has an MPX stereo indicator that lights when the dial pointer crosses a station broadcasting MPX stereo. A unique circuit using a transistor operates the MPX stereo indicator. The transistor is controlled by a differential detecting circuit that amplifies the 19KC pilot signal. This circuit automatically discriminates between the 19KC signal and noise.

AUDIO

The MX110 audio amplifier consists of three negative-feedback amplifying sections in duplicate for the left and right stereo channels and a separate L+R monophonic amplifier. The first section in each channel is a feedback preamplifier used to amplify and compensate for the input signals coming from phonograph pickups or tape heads. Level set controls are connected into the output circuit of this preamplifier section when the INPUT SELECTOR is switched to PHONO 1 or PHONO 2. These controls may be used to maintain uniform loudness between phono and tuner inputs. Skillful layout, grounding, and shielding for low-hum pickup, metal film resistors, low-noise tubes and extreme care in manufacturing combine to reduce noise and hum in the input amplifiers.

The second amplifier section in each channel is a cathode follower. The sharp cut-off

(18db per octave) rumble and high-frequency filters are associated with this section. Input-level set controls for the auxiliary inputs are associated with this section. All the level set controls are conveniently accessible

The third amplifier section is a two stage negative feedback amplifier. The variable bass and treble controls are included in the feedback loop to maintain the lowest possible distortion. For example a wave meter analysis of the three amplifier sections of the MX110 shows less than 1/10 of 1% distortion at 3 volts output. The MODE SELECTOR, balance controls and left and right outputs are associated with the third amplifier section.

The L+R monophonic amplifying section is a feedback summing amplifier. It supplies monophonic output as well as L+R output.

POWER SUPPLY

The power supply of the MX110 has received very special design attention. Three separate rectifier circuits are used.

First, a full-wave rectifier supplies D.C. to the heaters of all audio stages.

A second bridge rectifier supplies D.C. to the anodes of the audio stages.

Then a third full-wave rectifier supplies

D.C. to the tuner stages.

This elaborate power supply design insures the lowest possible background hum level and also the maximum stability. In addition to this careful work the power transformer uses special magnetic shielding to minimize possible hum pickup in the MX110 as well as in any other equipment used with it.

MECHANICAL SPECIFICATIONS

Dimensions

Chassis: 16 inches wide; $5\frac{7}{16}$ inches high;
13 inches deep including connectors.

Front Panel: 16 inches wide; $5\frac{7}{16}$ inches high.

Knob Clearance: $1\frac{1}{2}$ inches.

Weight

Chassis: $27\frac{1}{2}$ pounds.

Shipping Weight: 36 pounds.

Finish

Anodized gold and black (front panel).

Installation

Convenient, professional PANLOC.

TUNER SPECIFICATIONS

Sensitivity

Better than 2.5 microvolts at 100% modulation.

R.F. Amplifier

Cascode.

I.F. Amplifiers

Four.

Limiters

Two.

I.F. Bandwidth

200KC flat top.

I.F. Transformers

Mechanically captive.

Muting

I.F. injected.

Tuning Indicator

Tuning is indicated by an electron ray tube.

Frequency Response

Within ± 1 db 20 to 20,000 cycles. (Including 75 microseconds deemphasis.)

Hum

Greater than 70db or more below 100% mod. (Audio tubes have D.C. on the filaments.)

Drift

Less than 25 KC.

Ant. Input Impedance

300 balanced, 75 ohms unbalanced.

Radiation

Substantially below F.C.C. requirements.

Distortion

Less than 0.6% distortion at 100% modulation, ± 75 KC deviation above 2.5 microvolts at antenna.

MULTIPLEX DECODER SPECIFICATIONS

MPX Decoder

Hum Level: Better than 60db below 100% stereo modulation.

Distortion: Less than 0.3% (Multiplex Decoder only).

Channel Separation: Better than 30db at 1000 cps.

Suppression of Pilot (19KC), and Carrier (38KC): Greater than 40db below 100% modulation.

Front Panel Stereo Indicator Light: Activated by 19KC pilot carrier only.

AUDIO SPECIFICATIONS

Inputs

Total 5 each channel:

AUX.;

PHONO 1 MAG. or XTAL;

PHONO 2 MAG.;

TAPE HEAD;

TAPE MONITOR.

Outputs

Main Stereo Outputs, 1 Tape Stereo Output, 1 L+R Output.

AC Aux Outlets

1 unswitched, 2 switched.

MECHANICAL SPECIFICATIONS

Dimensions

Chassis: 16 inches wide; $5\frac{7}{16}$ inches high;
13 inches deep including connectors.
Front Panel: 16 inches wide; $5\frac{7}{16}$ inches high.
Knob Clearance: $1\frac{1}{2}$ inches.

Weight

Chassis: $27\frac{1}{2}$ pounds.
Shipping Weight: 36 pounds.

Finish

Anodized gold and black (front panel).

Installation

Convenient, professional PANLOC.

TUNER SPECIFICATIONS

Sensitivity

Better than 2.5 microvolts at 100% modulation.

R.F. Amplifier

Cascode.

I.F. Amplifiers

Four.

Limiters

Two.

I.F. Bandwidth

200KC flat top.

I.F. Transformers

Mechanically captive.

Muting

I.F. injected.

Tuning Indicator

Tuning is indicated by an electron ray tube.

Frequency Response

Within ± 1 db 20 to 20,000 cycles. (Including 75 microseconds deemphasis.)

Hum

Greater than 70db or more below 100% mod. (Audio tubes have D.C. on the filaments.)

Drift

Less than 25 KC.

Ant. Input Impedance

300 balanced, 75 ohms unbalanced.

Radiation

Substantially below F.C.C. requirements.

Distortion

Less than 0.6% distortion at 100% modulation, ± 75 KC deviation above 2.5 microvolts at antenna.

MULTIPLEX DECODER SPECIFICATIONS

MPX Decoder

Hum Level: Better than 60db below 100% stereo modulation.
Distortion: Less than 0.3% (Multiplex Decoder only).
Channel Separation: Better than 30db at 1000 cps.

Suppression of Pilot (19KC), and Carrier (38KC): Greater than 40db below 100% modulation.

Front Panel Stereo Indicator Light: Activated by 19KC pilot carrier only.

AUDIO SPECIFICATIONS

Inputs

Total 5 each channel:
AUX.;
PHONO 1 MAG. or XTAL;
PHONO 2 MAG.;
TAPE HEAD;
TAPE MONITOR.

Outputs

Main Stereo Outputs, 1 Tape Stereo Output,
1 L+R Output.

AC Aux Outlets

1 unswitched, 2 switched.

Controls

Input Selector: Total 6 positions: AUX, MPX, FM, PHONO 1, PHONO 2, TAPE HEADS.

Mode Selector: Total 7 positions: L TO L&R, R TO L&R, STEREO REV., STEREO, MONO, L+R TO L, L+R TO R.

Tone: Dual treble and bass negative-feedback controls with slip clutch for independent adjustment of each channel. Bass Boost: 15db at 50 cycles. Bass Cut: 18db at 50 cycles. Treble Boost: 15db at 10,000 cycles. Treble Cut: 15db at 10,000 cycles.

Balance: Turn to right to emphasize the right channel. Turn to the left to emphasize the left channel.

Phase: 2 positions: NORMAL or REVERSED: Changing phase does not increase distor-

tion. H.F. Cutoff Filter: 2 positions: Flat, or 5KC cutoff. (20db per octave.) L.F. Cutoff Filter: 2 positions: Flat, or 50 cycles cutoff. (20db per octave.)

Loudness: Fletcher Munson compensation.

Tape Monitor: 2 positions: IN and OUT. For comparison of recorded tape with program source after recording.

Tuning: Flywheel tuning—no backlash.

Muting: 2 positions: IN or OUT for interstation noise suppression.

Level Set: Three left and three right controls. 2 for AUX, 2 for PHONO 1, and 2 for PHONO 2. These controls are located back of the front panel on the top of the MX110.

AC Power—Concentric with BALANCE control: ON-OFF.

ELECTRICAL SPECIFICATIONS

Frequency Response

$\pm 1/2$ db 20 to 20,000 cycles.

Distortion

Less than 0.2% at rated output.

Hum and Noise

High-level inputs: 80db below rated output.

Low-level inputs: less than 3 microvolts at input terminals.

Input Sensitivity

AUX: 0.3 volt at 200K.

PHONO 1: 3 millivolts at 47K.

PHONO 2: 3 millivolts at 47K.

TAPE HEAD: 3 millivolts at 220K.

TAPE MONITOR: 0.3 volt at 100K.

Outputs

MAIN: 3 volts 2 in parallel each channel.

L+R: 3 volts.

TAPE: From FM at 100% modulation 0.9 volt from PHONO when cartridge output is 9.0 millivolts—0.9 volt; with rated input —0.3 volt.

POWER REQUIREMENTS: 105-125 volts AC 50/60 cycles; 75 watts.

FUSE: 1 amp. Slo-Blo.

TUBE COMPLEMENT

1	6DS4	R.F.-1 amplifier (nuvistor)	1	12AU7	MPX 38KC Oscillator
1	12AT7	R.F.-2 mixer	1	12AX7	Phono Preamplifier Left
1	6AB4	Oscillator	1	12AX7	Phono Preamplifier Right
1	6AU6	IF-1	1	12AX7	Left and Right 2nd Audio Amplifier
1	6AU6	IF-2	1	6U8	Left 3rd Audio Amplifier
1	6AU6	IF-3/Limiter 1	1	6U8	Right 3rd Audio Amplifier
1	6CS6	IF-4/Limiter 2	2	Diodes	Discriminator
1	12AT7	Muting/L+R Amplifier	1	Diode	Muting and Tuning Eye Detectors
1	6HU6/EM87	Tuning Indicator	1	Diode	AGC Clamp
1	6D10	FM AUDIO/Left and Right 1st Audio Amplifier	4	Diodes	Balanced MPX Detectors
1	6U8	MPX Amplifier and 19KC Separator/Indicator control	2	Diodes	Balanced Det. for Indicator Light

- | | | | |
|---|--------------------|-----------------------|-----------------------------|
| 2 Silicon Diodes | DC Filament Supply | 4 Selenium Rectifiers | High and Low Voltage Supply |
| 1 MA113 Transistor-Indicator Light Switch | | | |

FRONT PANEL INFORMATION

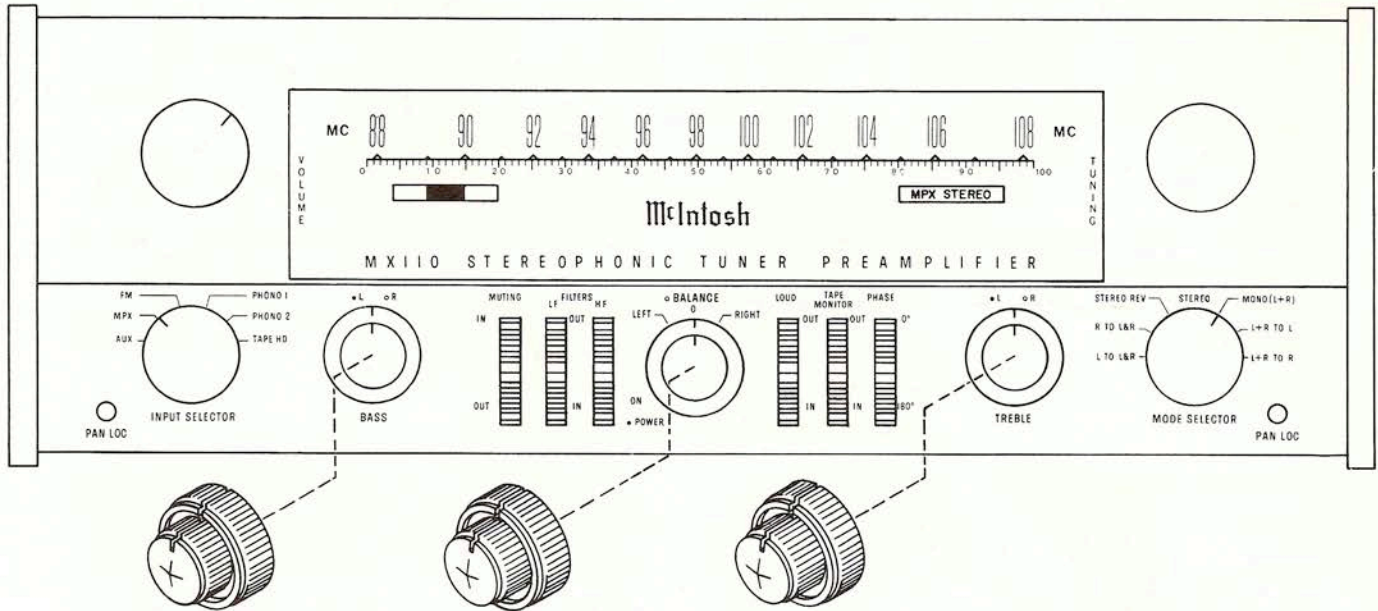

Figure 1. MX110 Front Panel.

DIAL SCALES

The MX110 has two scales. The 88 to 108 scale is marked in megacycles. The 0 to 100 scale is the logging scale. The logging scale can be used to accurately retune any station. You may find it easier to keep a record of your favorite stations by use of the logging scale.

INDICATORS

The MX110 has two indicators. They are just below each end of the logging scale. On the right end is the MPX STEREO indicator. On the left end is the tuning indicator.

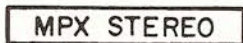

Figure 2. MPX Stereo Indicator.

The MPX STEREO indicator will light up if the dial pointer crosses a station broadcasting MPX stereo. A special circuit is used to operate this panel indicator. This circuit automatically detects the 19KC MPX stereo

signal while rejecting noise pulses of equal intensity. For listening to MPX stereo, refer to OPERATING INSTRUCTIONS on page 00.



The tuning indicator off tune.



The tuning indicator on tune.

Figure 3. Tuning Indicator.

The tuning indicator uses the movement of two electron beams inside a vacuum tube to show when a station is precisely tuned.

The beams move toward each other as the station comes into tune. The station is precisely tuned when the beams come closest together. The action of this indicator is substantially independent of the signal strength of the station. Only the very weakest signals will not close the beams.

VOLUME

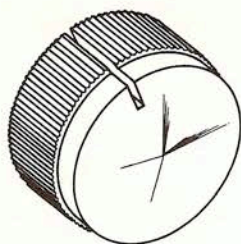

Figure 4. VOLUME Control.

The VOLUME control is the large knob located to the left side of the dial face. The volume control adjusts the loudness of both stereo channels and also the L+R monophonic channel.

INPUT SELECTOR

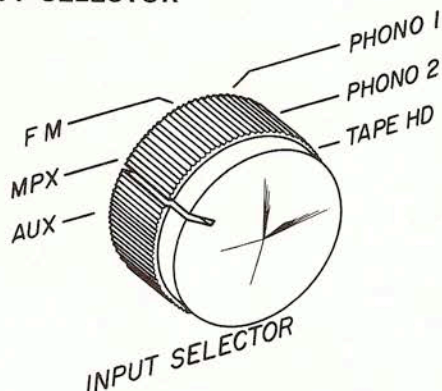

Figure 5. INPUT SELECTOR.

1. AUX—The AUX position of the INPUT SELECTOR connects the back panel jacks marked AUX through the MX110. Use these jacks to connect any high level program source through the MX110. Connections are made following the instructions on page 11 in the section titled CONNECTING. Operating procedure is on page 13 in the section titled OPERATING INSTRUCTIONS.

2. MPX—The MPX position of the INPUT SELECTOR connects the multiplex decoder to the output jacks of the MX110. Listen to MPX stereo broadcasts in this position. To properly connect and operate the MX110, consult the sections titled CONNECTING on page 11 and OPERATING INSTRUCTIONS on page 13.

3. FM—The FM position of the INPUT SELECTOR connects FM monophonic programs to

the output jack of the MX110. To properly operate the MX110, consult the section titled OPERATING INSTRUCTIONS on page 13.

4. PHONO 1—The PHONO 1 position of the INPUT SELECTOR connects the jacks on the back panel marked PH-1 MAG. and PH-1 XTAL through the MX110. Any stereophonic or monophonic magnetic phono cartridge plugged into the PH-1 MAG. jacks is fed through the MX110. Any constant amplitude cartridge such as a crystal or ceramic device plugged into the PH-1 XTAL jacks is fed through the MX110. To properly connect and operate the MX110 for use with phono cartridges, see the sections titled CONNECTING on page 11 and OPERATING INSTRUCTIONS on page 13.

5. PHONO 2—The PHONO 2 position of the INPUT SELECTOR connects the jacks on the back panel marked PH-2 through the MX110. Any magnetic phono cartridge plugged into the PH-2 jacks is fed through the MX110. To properly connect and operate the MX110 for use with phono cartridges, see the sections titled CONNECTING on page 11 and OPERATING INSTRUCTIONS on page 13.

6. TAPE HD—The TAPE HD position of the INPUT SELECTOR connects the jacks on the back panel marked TAPE HEAD through the MX110. A tape deck that does not contain its own playback preamplifier is connected to the MX110 through this position. To properly connect and operate the MX110 for use with tape decks, consult the sections titled CONNECTING on page 11 and OPERATING INSTRUCTIONS on page 13.

MODE SELECTOR

1. L TO L&R—The MODE SELECTOR in the L TO L&R position connects the left input to both amplifiers and both loudspeakers.

2. R TO L&R—The MODE SELECTOR in the R TO L&R position connects the right input to both amplifiers and both loudspeakers.

3. STEREO REV—The MODE SELECTOR in the STEREO REV position connects the left input to the right loudspeaker and right input to the left loudspeaker.

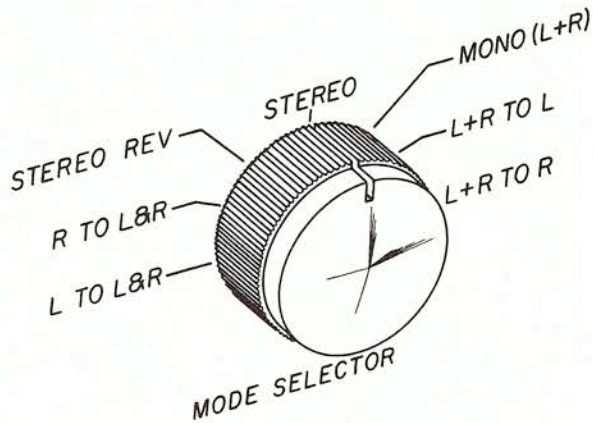

Figure 6. MODE SELECTOR.

4. STEREO—The MODE SELECTOR in the STEREO position connects the left input to the left loudspeaker and the right input to the right loudspeaker. This is the normal stereo position.

5. MONO—The MODE SELECTOR in the MONO position adds the left input to the right input and connects the L+R program to both amplifiers and both loudspeakers.

6. L+R TO L—The MODE SELECTOR in the L+R TO L position adds the left input to the right input and connects the L+R program to the left loudspeaker only.

7. L+R TO R—The MODE SELECTOR in the L+R TO R position adds left input to the right input and connects the L+R program to the right loudspeaker only.

BASS

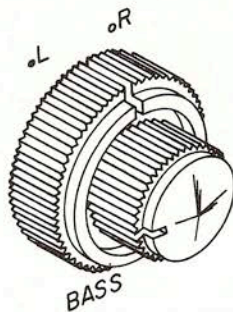

Figure 7. BASS Control.

The BASS control is a dual control. The two parts of the control are concentric. The center or small knob controls the bass loudness in the left channel. The outer ring controls the bass loudness in the right channel. The two knobs are friction coupled, this permits them to be adjusted together or inde-

pendently. Turning clockwise increases bass loudness. Turning them counterclockwise decreases bass loudness.

TREBLE

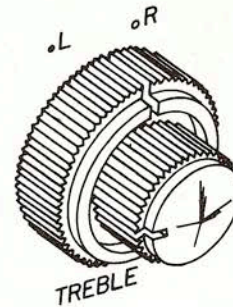

Figure 8. TREBLE Control.

The TREBLE control is a dual control. The two parts are concentric. The center or small knob controls the treble loudness in the left channel. The outer ring controls the treble loudness in the right channel. The two knobs are friction coupled. This permits them to be adjusted together or independently. Turning clockwise increases the treble loudness. Turning counterclockwise decreases treble loudness.

MUTING

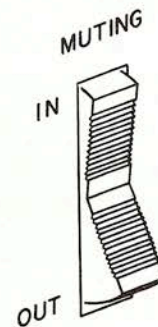

Figure 9. MUTING Control.

Muting suppresses the background noise and hiss normally heard between stations. With the control in the IN position the muting is turned on. Weak stations that may not override noise and interference are also suppressed by the muting.

In the OUT position, the muting is turned off. This allows conventional FM tuning with the noise and interference present. Use this position to tune weak or noisy stations.

FILTERS

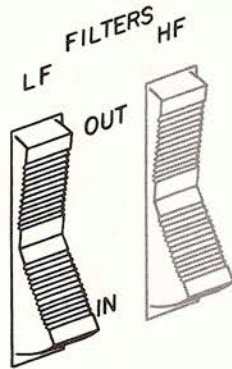

Figure 10. LF Rumble Filter Switch.

Low frequency noise below 50 cps is reduced by pushing the LF rumble filter switch to the IN position. Low frequency acoustically coupled feedback is also reduced by this switch.

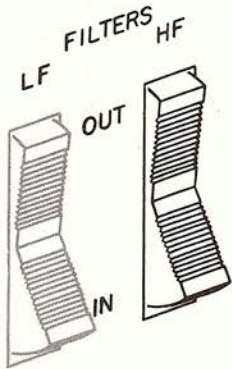

Figure 11. HF Filter Switch.

Surface noise above 5000 cycles is reduced when reproducing old, badly worn recordings by pushing the HF filter switch to the IN position.

POWER BALANCE

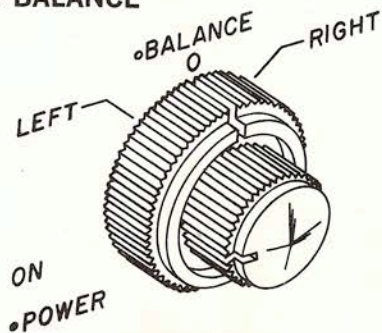

Figure 12. BALANCE Control.

The POWER ON-OFF switch is the center or small knob of this dual control. The MX110 is off when the POWER switch is turned to the

POWER OFF or left position (counterclockwise).

On the back panel of the MX110 there are three A.C. OUTLETS. Two of these are black and the other is red. The power to the black outlets is controlled by the POWER switch. The RED outlet is used for power to a turntable or a record changer. The turntable or record changer drive system is protected by this arrangement. It is necessary to turn off the turntable or record changer with its own control switch. The two black outlets and the red outlet are not fused. Maximum rating for these outlets is 350 watts total.

The BALANCE control balances the MX110 for unequal program sources. Turning the control to the left accents the left channel by reducing the right channel output. Turning the control to the right accents the right channel by reducing the left channel output.

LOUD

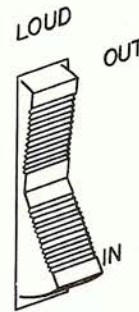

Figure 13. LOUD Compensation Switch.

When you turn down the volume, the music will seem to lose much of its bass and some of its treble. This effect is due to the sensitivity characteristic of human hearing. The response of the human ear to bass and treble pitch decreases more rapidly than its response to notes centered in the mid-tonal range. The LOUD control automatically provides the correct amount of bass and treble boost required to compensate for this change in response of the human ear at low-loudness levels. When the "LOUD" switch is moved to the IN position, it converts the volume control to a loudness compensated control. Use the LOUD IN to listen at low volume and still hear full-frequency range.

TAPE MONITOR

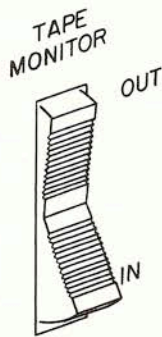

Figure 14. TAPE MONITOR Switch.

The TAPE MONITOR switch compares the recorded tape with the program source. When the TAPE MONITOR switch is in the OUT position, the program source is heard from the loudspeakers. When the TAPE MONITOR switch is in the IN position, the recorded tape is heard from the loudspeakers. Jacks marked TAPE MONITOR are located on the back panel. Plug a signal into these jacks from a tape machine which has a third head and a preamplifier for it. IMPORTANT: When the TAPE MONITOR switch is operated in the IN position, signal from any other source will not be heard from the loudspeakers. When not in use, make sure the switch is in the OUT position.

PHASE

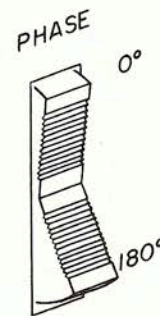
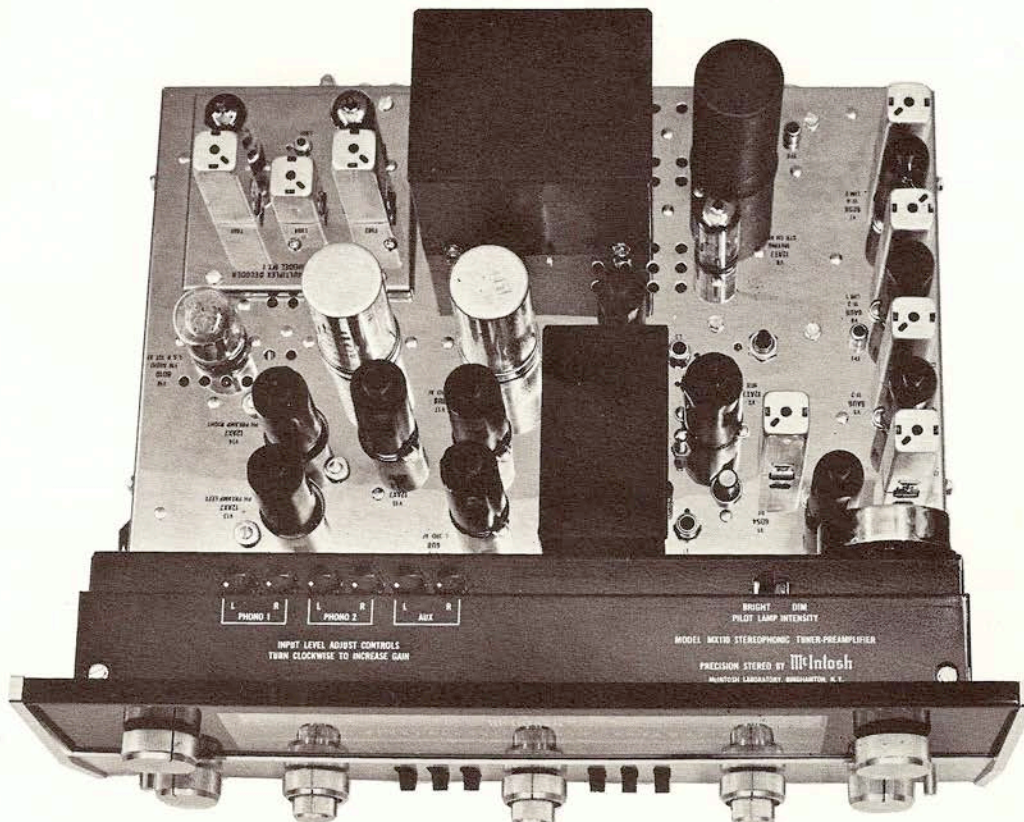

Figure 15. PHASE Switch.

The PHASE switch corrects for loudspeaker or program phasing. Placing this switch in the 180° position reverses phase in the left channel.

LEVEL SET CONTROLS

The MX110 LEVEL SET controls (see figure 16) compensate for the difference in output level from various program sources. The output level of the FM tuner, for example, is higher than the output of a magnetic pickup. When you switch from one program source to another, the level will vary to an annoying degree. The level controls can be set so that the output levels of all program sources are equal. The MX110 LEVEL SET controls are located on top of the MX110 chassis behind the front panel.



INSTALLATION

The MX110 can be installed in conventional furniture cabinets, custom built installations or professional relay racks. If the unit is to be placed on a shelf or table-top, it is recommended that it be housed in a McIntosh cabinet. Install the MX110 from the front of the cabinet, not from the rear.

To support the weight of the MX110, the wood panel used to mount it should be at least $\frac{1}{4}$ inch thick.

The MX110 installation should allow $13\frac{1}{2}$ inches behind the front panel which includes $1\frac{1}{2}$ inches for connectors. The desirable width and height of the installation are 16 inches and a minimum of $5\frac{1}{2}$ inches, respectively, so that sufficient space is allowed for the circulation of air. These are inside dimensions. The front panel mounting space width and height are 16 inches and $5\frac{3}{8}$ inches, respectively. Allow at least $1\frac{1}{2}$ inches for knob clearance in a custom built installation.

CONNECTING

AC CONNECTIONS

There are three AC outlets on the rear panel of the MX110. (See Figure 17.) These receptacles have a maximum rating of 350 watts total. The power to the two black receptacles is controlled by the POWER switch on the front panel. The red receptacle is not switched. The red receptacle is used for powering a turntable or record changer. The receptacle is not switched so that the turntable power will not be turned off while

the turntable idler wheel engaged. The turntable is protected by this arrangement because it is necessary to turn off the turntable with its own control switch so that no damage will result to the drive system.

AC POWER

Plug the AC power cord in 105 volt to 125 volt, 50 to 60 cycle power line. The power used by the MX110 is 75 watts.

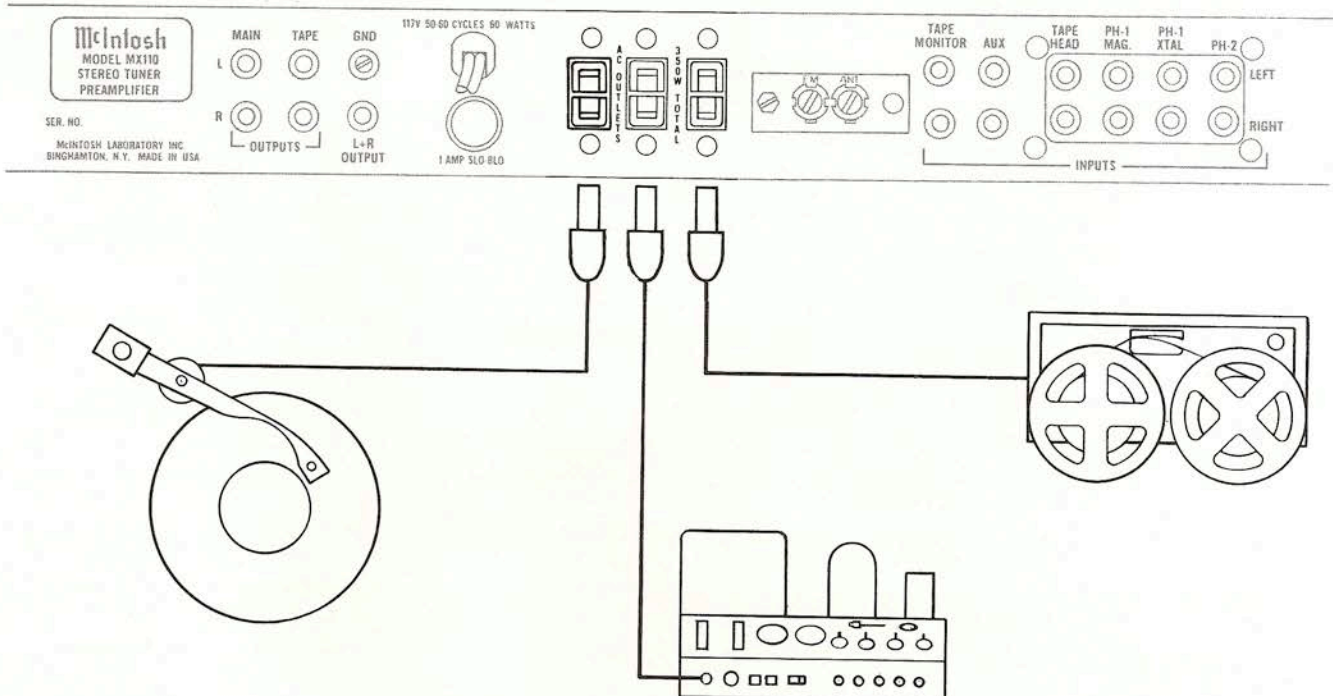

Figure 17. AC Connections.

INPUT CONNECTIONS

The MX110 provides six separate program inputs controlled by the INPUT SELECTOR switch. One input for tape monitor or

tape comparison is controlled by the TAPE MONITOR switch.

The input program connections should be made in accordance with Table 1.

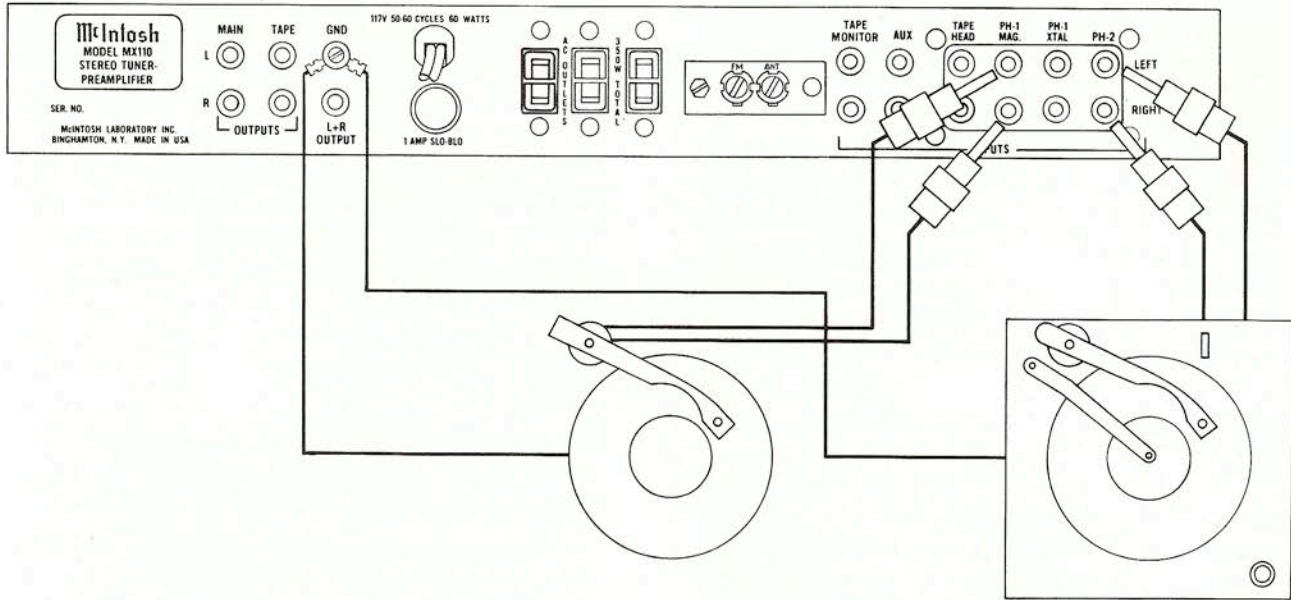

Figure 18. MX110 Input Connections (Back Panel).

If a cartridge requires less than 47,000 ohms load impedance, a resistor can be added across the terminals of the cartridge

to achieve the correct termination. The following chart may be used as a guide:

Desired Impedance
47,000 ohms (47K)
37,000 ohms (37K)
27,000 ohms (27K)
15,000 ohms (15K)
6,800 ohms (6.8K)

Resistor Across Input
No Resistor
180,000 ohms (180K)
62,000 ohms (62K)
22,000 ohms (22K)
8,200 ohms (8.2K)

Table 1. Input Connections

CONNECTION	FUNCTION	INPUT SENSITIVITY	INPUT IMPEDANCE
TAPE MONITOR	Tape input operates with tape machines containing their own playback preamplifier.	0.3 volts	100,000 ohms (100K)
AUX	The auxiliary input accepts any auxiliary service requiring flat frequency response, such as a T.V. set, etc.	0.3 volts	200,000 ohms (200K)
TAPE HEAD	This jack is used with a tape deck that does not contain its own playback preamplifier.	2.5 millivolts (25/1000 of 1 volt)	220,000 ohms (220K)
PH-1 MAG & PH-2 MAG.	These jacks are to be used with magnetic cartridges.	3 millivolts (3/1000 of 1 volt)	47,000 ohms (47K)
PH-1 XTAL	These jacks are to be used with a constant amplitude cartridge such as a crystal, ceramic, or frequency-modulated device.	0.1 volts	220 mmf in series with 56K

OUTPUT CONNECTIONS

There are three sets of outputs on the left half of the back panel. (See Figure 19.) One pair is marked MAIN. The second pair is marked TAPE. The third is a single jack marked L+R OUTPUT.

The MAIN output connects to power amplifiers (Figure 19). The TAPE output feeds a tape recorder.

The MAIN jacks are fed from cathode followers. Longer cables than are normally supplied can be connected between the MX110 and the amplifiers. The length of the cable is limited by the capacity of the cable. The total capacity must not exceed 1000 mmf. For instance: cables with a capacity of 25 mmf per foot may be 40 feet long; 13.5 mmf per foot cable may be 75 feet long. The input impedance of the amplifiers should be 100,000 ohms or greater.

The TAPE output is fed from a cathode follower. The program material fed out of the TAPE output is not affected by these front

panel controls: VOLUME control, BASS controls, LF and HF filter switches, BALANCE control, LOUD switch, TAPE MONITOR switch, PHASE switch, TREBLE controls, and MODE SELECTOR switch.

The program material fed out of the TAPE output is affected by these front panel controls: INPUT SELECTOR switch, and in the FM or MPX positions of the INPUT SELECTOR, the MUTING switch and TUNING control.

The input impedance of the tape recorder should be 100,000 ohms or greater.

A jack marked L+R OUTPUT is located below the GND screw.

A monophonic signal can be distributed to other rooms by connecting another power amplifier to the jack marked L+R. The cable connecting this output to the amplifier should not have a capacity of more than 1000 mmf. The input impedance of the power amplifier connecting to this output should not be less than 150,000 ohms (150K).

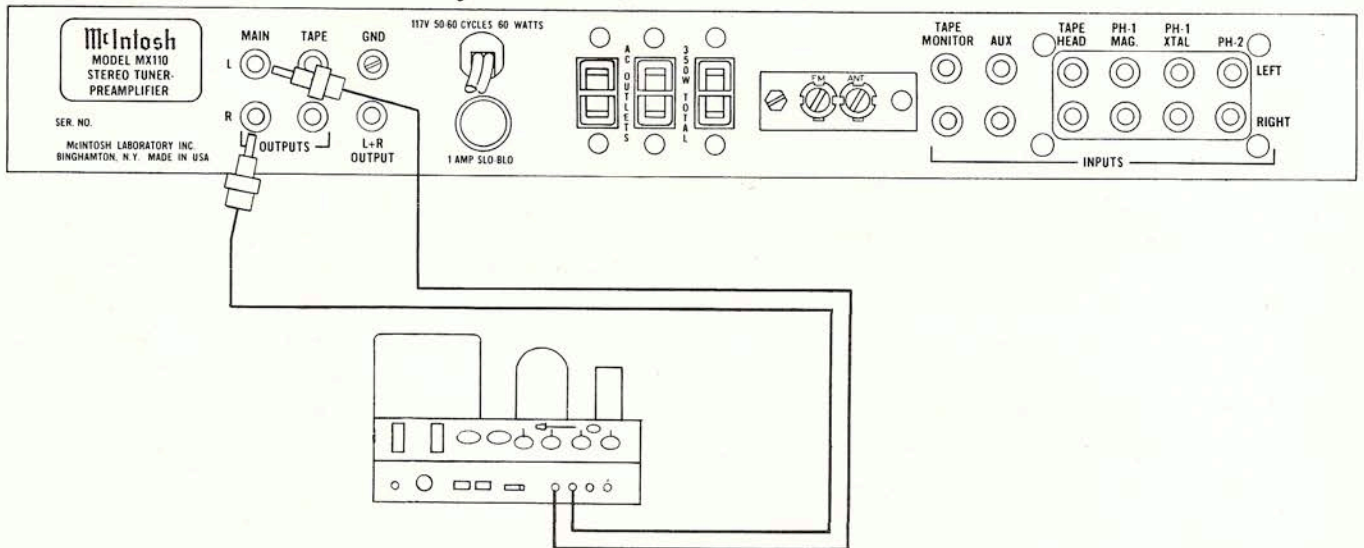

Figure 19. Output Connections

ANTENNA CONNECTIONS

Satisfactory MPX stereo requires about 10 times as much signal from the antenna. Monophonic installations that are satisfactory on an indoor antenna may require the use of an outdoor antenna for equivalent results.

With the MX110 one of the three antenna systems can be used: (1) the indoor dipole supplied with the MX110, (2) an outdoor

FM antenna, or (3) a VHF-TV antenna. In fringe areas best results will probably be obtained with the use of an outdoor FM antenna. In many areas the indoor dipole antenna may be satisfactory. The use of a VHF-TV antenna is also effective in many installations. Make a choice after consulting the book on antennas titled "Themes and Variations" included with MX110.

OUTDOOR ANTENNA

An outdoor antenna is recommended for optimum performance in all areas. In fringe (outlying) areas, best results will be obtained with a highly directional FM antenna used in conjunction with a rotator. Rotate the antenna until the best reception is obtained. Connect the 300 ohm antenna to the terminal screws marked FM ANT as in Figure 20.

INDOOR DIPOLE ANTENNA

The flexible folded dipole antenna (300 ohm) supplied with the MX110 is for indoor use in urban or high intensity signal areas. The flexibility of the thin flat wire assembly permits it to be placed under a rug, tacked behind the hi-fi equipment enclosure . . . or, placed in any other convenient location. In some cases, it may be necessary to "position" the antenna for best signal reception. This should be done before it is permanently located or tacked down.

To position the dipole for best results, the MX110 must be operating. The following procedure may be followed: Connect the two leads from the dipole to the terminals marked FM ANT on the rear of the chassis of the MX110, see Figure 20.

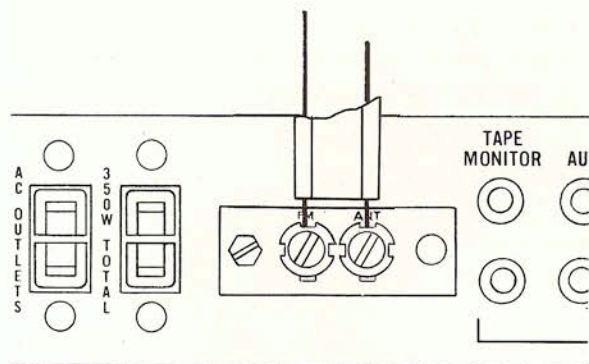

Figure 20. Connection for 300 ohm antenna

IMPORTANT:

BEFORE TURNING THE MX110 ON, CHECK TO SEE THAT ALL TUBES ARE FIRMLY SEATED IN THEIR SOCKETS, AND THAT ALL PLUGS ARE CORRECTLY AND FIRMLY INSERTED.

Turn the POWER switch ON. Then the MODE SELECTOR to STEREO. Place the MUTING control in the OUT position. Open the dipole to a full "T" and tune the MX110 to a fairly weak station. Rotate and move the dipole about until the best reception is obtained. The dipole is now in the best position for maximum signal reception for this station. This is not a critical position; therefore you may permanently install the antenna in a position which most closely conforms to it.

Keep the dipole away from metal surfaces, metal doorways, etc., as they usually interfere with its efficiency.

CONNECTING A 75 OHM COAXIAL ANTENNA LEAD

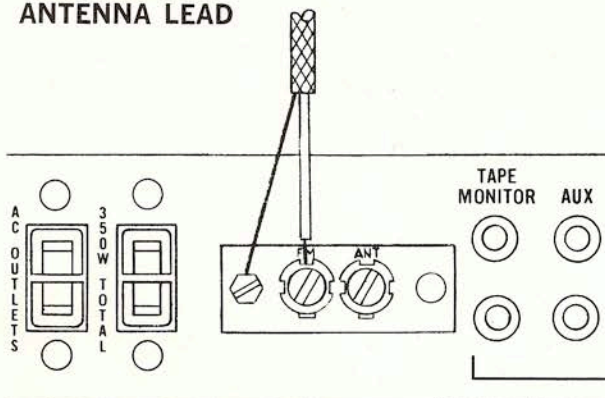

Figure 21. Connections for a 75 ohm antenna

An unbalanced 75 ohm antenna can be connected to the MX110 with coaxial cable. Connect the center conductor to the left FM ANT screw and the shield to the grounding screw next to the antenna screw as in Figure 21. The McIntosh designed balun matches the 75 ohm input to the tuner for optimum performance.

OPERATING INSTRUCTIONS

BALANCING A STEREO SYSTEM

The performance and enjoyment of a stereo system is greatly increased when the system is properly balanced. There are

two factors that require balancing. One is unequal program loudness in each channel. The knob marked BALANCE on the MX110

is used to balance unequal program loudness. Balancing program for equal loudness is explained under ADJUSTING BALANCE CONTROL TO CORRECT PROGRAM MATERIAL.

The other factor that requires balancing is system balance. The balance of the stereo system is affected by many things including room acoustics, furniture placement, room shape, small differences in loudspeakers, etc. Balancing the system is done by adjusting the controls on the power amplifiers.

To begin balancing the system, check to see that the controls on the amplifier are properly set. If the amplifier is a McIntosh MC225, set the input switch to STEREO. Turn both input level controls to the black dot at the 12 o'clock position of the control.

If the amplifier is a McIntosh MC240 or MC275 check to see that the cables from the MX110 are plugged into the STEREO INPUT jacks. Then set the lever switch to STEREO. Turn the BALANCE control to the 0 mark at the 12 o'clock position of the control. The amplifiers are now ready for the rest of the steps to balancing the system.

1. Play a familiar recording on the record player.

2. Push the two PANLOC buttons to release the MX110 from the mounting shelf. Pull the MX110 toward you until the latch locks engage. Turn all the INPUT LEVEL ADJUST controls full on (clockwise).

3. Turn the INPUT SELECTOR to the PHONO position into which the record player is connected.

4. Turn the BASS controls and TREBLE controls so that the knob indicator is centered between the panel markings L and R.

5. Turn the BALANCE control to the center or 12 o'clock position.

6. Place the LOUD switch in the OUT position.

7. Place the TAPE MONITOR switch in the OUT position.

8. Place the PHASE switch in the 0° position.

9. Place the LF rumble filter switch in the OUT position.

10. Place the HF cutoff filter switch in the OUT position.

11. Turn the MODE SELECTOR to the L+R TO L position.

12. While the program is playing, alternate the MODE SELECTOR between the L+R TO R and the L+R TO L position. On amplifiers such as the MC225, adjust the correct gain control until the loudspeakers are of equal loudness. On the MC240 or the MC275, turn the balance control until the loudspeakers are of equal loudness.

The stereo system is now balanced. It will remain balanced through all modes of operation. Leave the MX110 extended on its PANLOC stops for the next series of adjustments.

ADJUSTING PHASE

1. Set the MODE SELECTOR to STEREO.

2. Turn the BASS controls and TREBLE controls to straight up position so that the dial indicator centers between the panel markings • L and ° R.

Stand approximately 10 feet in front of and midway between the loudspeakers. The source of sound should appear to be directly in front of you. Alternate the PHASE switch between 0° and 180°. If the sound is not directly in front of you in the 0° position, reverse the leads to one loudspeaker. The PHASE control is used to correct phase in the source material whenever necessary.

BALANCING LOUDNESS BETWEEN PROGRAM SOURCES

The MX110 has set level controls in the AUXILIARY, PHONO 1 and PHONO 2 inputs. These adjustments allow you to make any program material connected to the auxiliary and phono inputs the same loudness as the tuner. To make this adjustment proceed as follows:

1. Turn the MODE SELECTOR to MONO (L+R).

2. Turn the INPUT SELECTOR to FM. Adjust the VOLUME control to a comfortable listening level.

3. While the record is playing, turn the MODE SELECTOR to the L+R to L position.

4. Now switch the INPUT SELECTOR between FM and PHONO. If the record is louder than the FM turn the INPUT LEVEL, ADJUST CONTROL marked PHONO L down (counterclockwise). When the loudness of FM and the record are equal, the left channel level is correct.

5. Turn the MODE SELECTOR to L+R to R.

6. Again switch the INPUT SELECTOR between FM and PHONO. If the record is louder than the FM, turn the INPUT LEVEL ADJUST CONTROL marked PHONO R down (counterclockwise). When FM and the record are equal, the right channel is correct.

Use these same steps to adjust the AUX input loudness. Remember to compare the loudness to the FM only. The FM does not have controls for loudness adjustment.

ADJUSTING BALANCE CONTROL AFTER THE SYSTEM HAS BEEN BALANCED

When these instructions have been completed, the overall system is balanced and in phase; ready to deliver maximum pleasure and enjoyment.

You may hear differences in balance from one record to another or from one tape to another. Some records or tapes may be recorded with slight differences between channels. The differences can be corrected with the BALANCE control on the front panel. If the difference is heard on every record, then the cartridge may have a very small difference in output.

ADJUSTING FOR SPECIAL EFFECTS

HF Cutoff Filter. If you wish to reproduce old, badly worn records, you can minimize the surface noise by switching the HF cutoff filter to the IN position. (See section entitled "Front Panel Facilities," page 5.)

LF Rumble Filter. If you are using a turntable or changer which has low-frequency rumble noise, you may reduce it by pushing the LF rumble filter switch to the IN position.

Bass Controls and Treble Controls. The tone balance which you hear when listening to an orchestra is affected by the conductor's instructions to his musicians, the acoustical environment in which you are listening, and your own subjective hearing interpretation.

Considering these conditions, it is easy to see why tone balance controls play a major role in correcting for the following factors:

1. Each person's subjective idea of tone balance.

2. Loudspeaker frequency response characteristics.

3. Loudspeaker placement in the listening room.

4. The conductor's idea of tone balance at the time the recording was made.

5. The microphone frequency response characteristics.

6. The recording process influences.

These factors can be considered as environmental influences. The BASS controls and TREBLE controls are designed to provide a degree of compensation for effects of environment. Listen to your system with each control set with the indicators centered between the panel markings • L and ° R. If you wish to reduce treble in relation to bass, turn the TREBLE controls counterclockwise until the tone balance sounds correct to you. These controls will modify tone balance without introducing any undesirable effects. Do not be surprised if you find your preference in tone changing from time to time.

Loudness. Due to a selective shift in sensitivity of human hearing, music reproduced at very low volume loses its bass and treble.

The LOUD switch on the MX110 changes the VOLUME control to a loudness compensated control to correct for this effect. When you wish to listen to music at a greatly reduced loudness level and yet hear bass and treble, set the LOUD switch to the IN position.

Phase. If the stereo sound seems to come from either side of the room instead of being distributed between the loudspeakers, adjust the PHASE control to 180°. This listening effect is due to reproducing sound that is out of phase from one channel to the other. You will find some records differ from others in this respect and that some tapes differ from records.

LISTENING TO A MONOPHONIC FM PROGRAM

1. Turn the INPUT SELECTOR to FM.

2. Turn the MODE SELECTOR to MONO

(L+R)

3. Place the PHASE switch in the 0° position.

4. Place the HF cutoff filter switch in the OUT position. (See page 15 ADJUSTING FOR SPECIAL EFFECTS.)

5. Place the LF rumble filter switch in the OUT position. (See page 15 ADJUSTING FOR SPECIAL EFFECTS.)

6. Place the LOUD switch in the OUT position. (See page 15 ADJUSTING FOR SPECIAL EFFECTS.)

7. Turn the BASS controls and TREBLE controls so that the indicator is centered between the panel markings • L and ° R. (See page 15 BASS AND TREBLE CONTROLS.)

8. Place the MUTING switch in the IN position.

9. Adjust the VOLUME control to the desired volume.

After a warm up of about 30 seconds, turn the tuning knob to find the station of your choice.

While tuning the MX110 you may notice that the tuning indicator will show a station yet no program is heard from the speakers. The muting circuit in the tuner is rejecting the station because there is objectionable noise with the weak signal from the station. Push the MUTING switch to the OUT position and the station will be heard. Most programs that can be tuned in this manner are of poor quality due to interfering noise.

LISTENING TO MPX STEREO

If you are tuning the MX110 and the red MPX indicating light comes on, this indicates a multiplex broadcast. To listen to this program:

1. Turn the INPUT SELECTOR to MPX.
2. Turn the MODE SELECTOR to STEREO.

LISTENING TO A STEREO RECORD

To listen to stereo records, proceed as follows:

1. Turn the INPUT SELECTOR to PHONO 1 or PHONO 2, whichever is connected to the cartridge you wish to hear.
2. Set the MODE SELECTOR to STEREO.
3. Set the PHASE switch to 0°.
4. Set the HF cutoff filter to OUT. (See page 15 ADJUSTING FOR SPECIAL EFFECTS.)

5. Place the LF rumble filter control in the OUT position. (See page 15 ADJUSTING FOR SPECIAL EFFECTS.)

6. Set the LOUD control to OUT. (See page 15 ADJUSTING FOR SPECIAL EFFECTS.)

7. Set the BASS controls and TREBLE controls so that the indicator is centered between the panel markings • L and ° R. (See page 15 BASS AND TREBLE CONTROLS.)

8. Adjust the VOLUME control to the desired volume.

LISTENING TO MONOPHONIC RECORDS

To listen to monophonic records, proceed as follows:

1. Turn the INPUT SELECTOR to PHONO 1 or PHONO 2 whichever is connected to the cartridge you wish to hear.

2. Set the MODE SELECTOR to MONO (L+R).

3. Set the PHASE switch to 0°.

4. Set the HF cutoff filter to OUT. (See page 00 ADJUSTING FOR SPECIAL EFFECTS.)

5. Place the LF rumble filter control in the OUT position. (See page 15 ADJUSTING FOR SPECIAL EFFECTS.)

6. Set the LOUD control to OUT. (See page 00 ADJUSTING FOR SPECIAL EFFECTS.)

7. Set the BASS controls and TREBLE controls so that the indicator is centered between the panel markings • L and ° R. (See page 15 BASS AND TREBLE CONTROLS.)

8. Adjust the VOLUME control to the desired volume.

LISTENING TO TAPE DECKS

To listen to tape from a tape deck, proceed as follows:

1. Turn the INPUT SELECTOR to TAPE HEAD.

2. Set the MODE SELECTOR to MONO (L+R) or STEREO, depending on the program on the tape.

3. Set the PHASE switch to 0°.

4. Set the HF cutoff filter to OUT. (See page 15 ADJUSTING FOR SPECIAL EFFECTS.)

5. Place the LF rumble filter control in the OUT position. (See page 15 ADJUSTING FOR SPECIAL EFFECTS.)

6. Set the LOUD control to OUT. (See page 15 ADJUSTING FOR SPECIAL EFFECTS.)

7. Set the BASS controls and TREBLE controls so that the dial indicator is centered between the panel markings • L and ° R.

8. Adjust the VOLUME control to the desired volume.

LISTENING TO A STEREO TAPE MACHINE

A stereo tape machine with its own playback preamplifiers should be plugged into the AUX input or the TAPE MONITOR input—not the TAPE HEAD input.

If the AUX input is used, proceed as follows:

1. Turn the INPUT SELECTOR to AUX.

2. Set the MODE SELECTOR to MONO (L+R) or STEREO depending on the program on the tape.

3. Set the PHASE switch to 0°.

4. Set the HF cutoff filter to OUT. (See page 00 ADJUSTING FOR SPECIAL EFFECTS.)

5. Place the LF rumble filter control in the OUT position. (See page 15 ADJUSTING FOR SPECIAL EFFECTS.)

6. Set the LOUD control to OUT. (See page 00 ADJUSTING FOR SPECIAL EFFECTS.)

7. Set the BASS control and TREBLE controls so that the dial indicator is centered between the panel markings • L and ° R.

8. Adjust the VOLUME control to the desired volume.

If the TAPE MONITOR input is used proceed as follows:

1. Push the TAPE MONITOR switch to IN.

2. Set the MODE SELECTOR switch to MONO (L+R).

3. Set the PHASE switch to 0°.

4. Set the HF cutoff filter to OUT. (See page 15 ADJUSTING FOR SPECIAL EFFECTS.)

5. Place the LF rumble filter control in the OUT position. (See page 15 ADJUSTING FOR SPECIAL EFFECTS.)

6. Set the LOUD control to OUT. (See page 15 ADJUSTING FOR SPECIAL EFFECTS.)

7. Set the BASS controls and TREBLE controls so that the dial indicator is centered between the panel markings • L and ° R.

8. Adjust the VOLUME control to the desired volume.

OPERATING CURVES

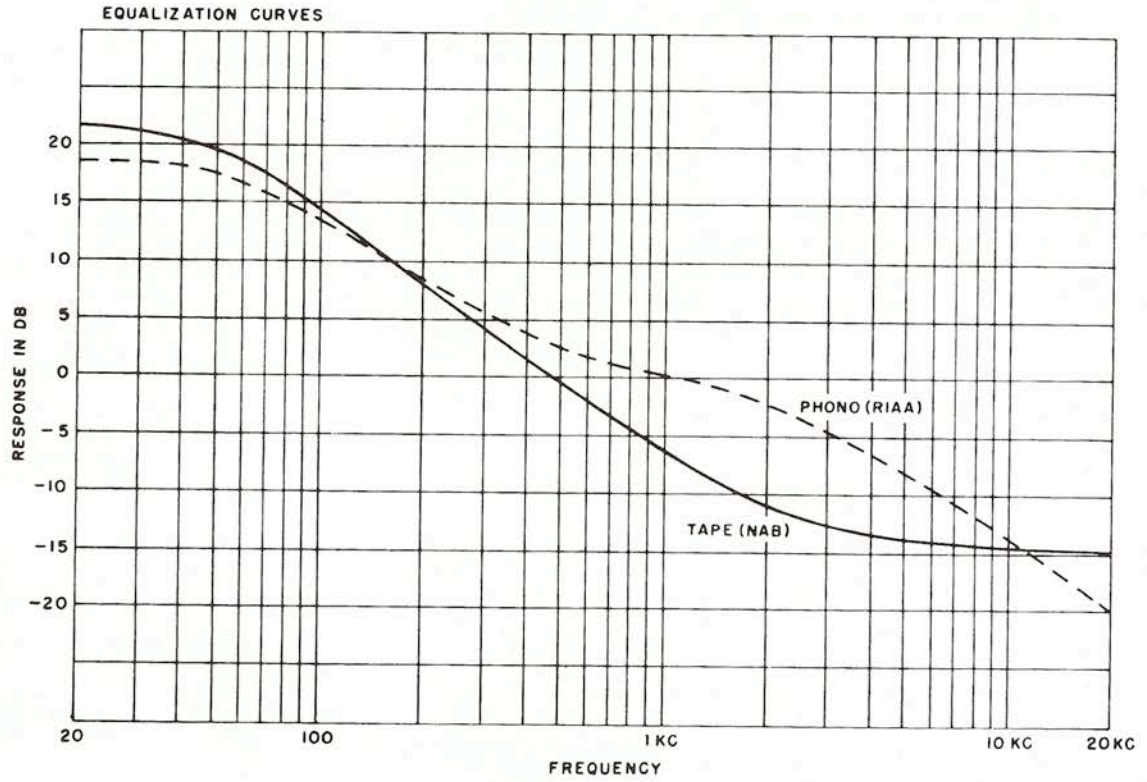

Figure 22. Equalization Curves.

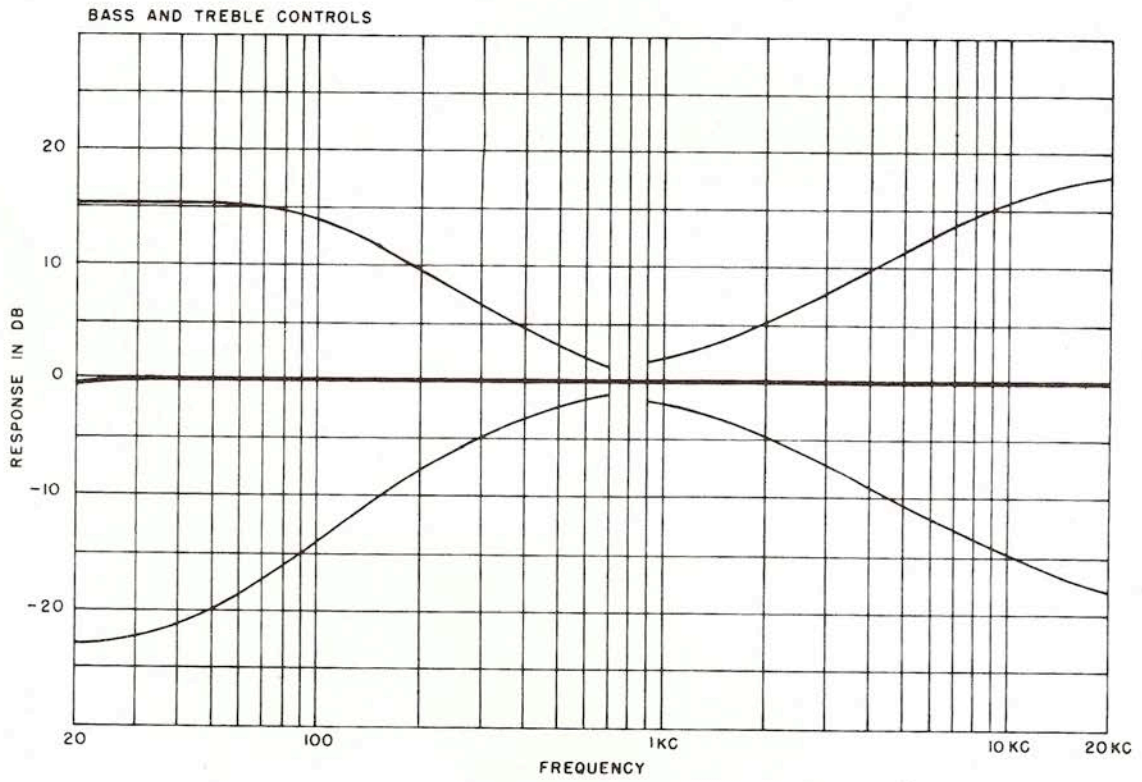

Figure 23. Bass and Treble Controls.

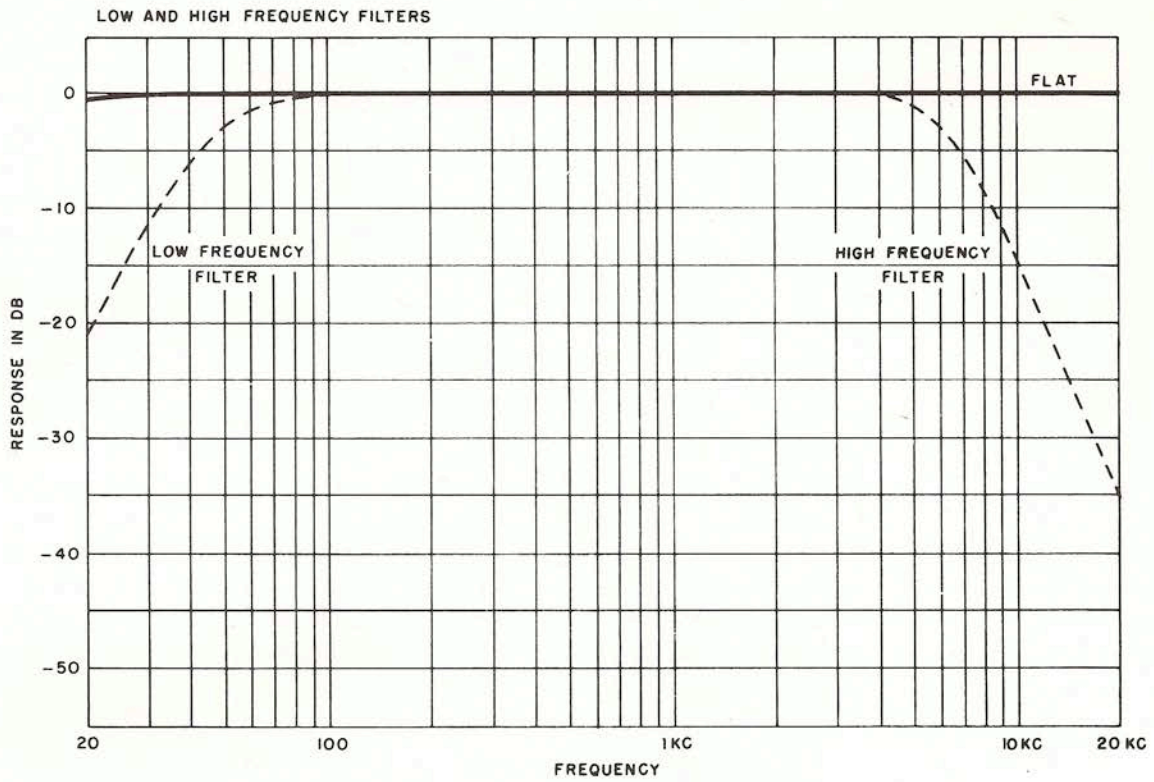

Figure 24 L.F. Filter and H.F. Filter.

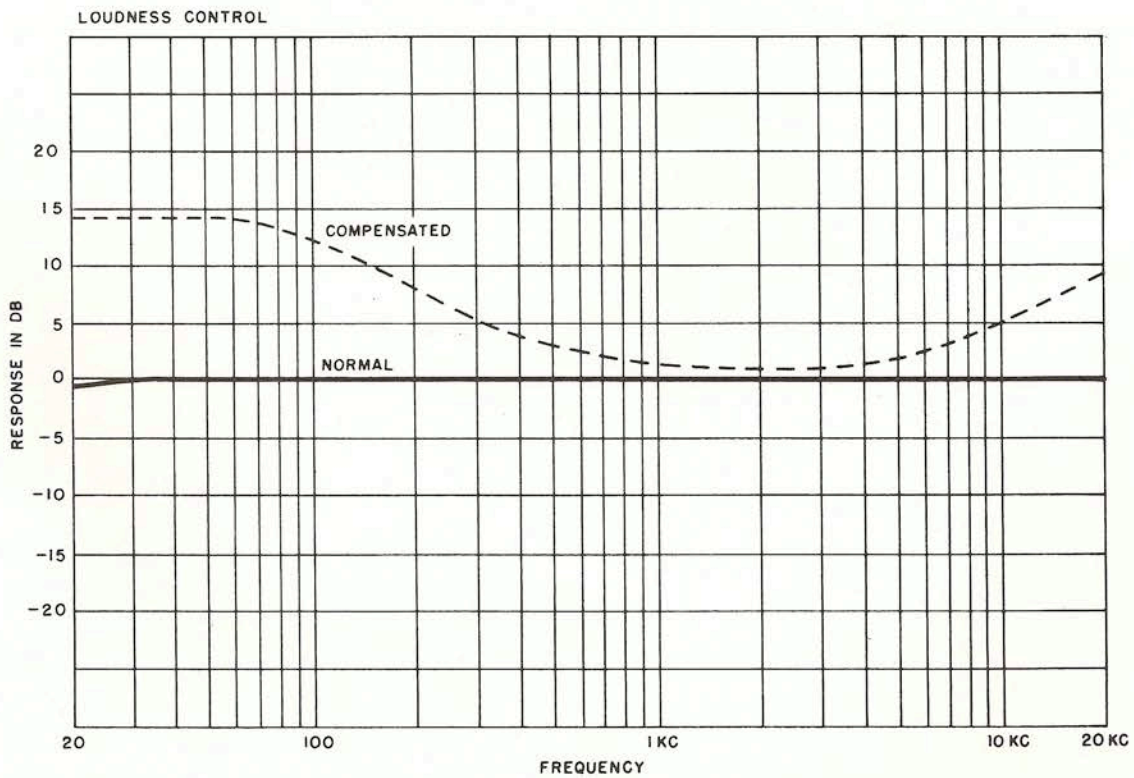

Figure 25 Loudness Control.

Your MX110 will give you many years of pleasant and satisfactory performance. If you have any questions concerning the operation or maintenance of this tuner-preamplifier please contact:

Customer Service
McIntosh Laboratory Inc.
2 Chambers Street
Binghamton, New York

Our telephone number is 723-5491.
The direct dial area code is 607.

GUARANTEE

McIntosh Laboratory Incorporated guarantees this equipment to perform as advertised. We also guarantee the mechanical and electrical workmanship and components of this equipment to be free of defects for a

period of 90 days from date of purchase. This guarantee does not extend to components damaged by improper use nor does it extend to transportation to and from the factory.

3-YEAR FACTORY SERVICE CONTRACT

An application for a FREE 3-YEAR FACTORY SERVICE CONTRACT is included in the pocket in the back cover of this manual. The FREE 3-YEAR FACTORY SERVICE CONTRACT will be issued by McIntosh Laboratory upon receipt of the completely filled out application form. If the application is not

mailed to McIntosh Laboratory, only the services offered under the standard 90-day guarantee will apply on this equipment. TAKE ADVANTAGE OF 3 YEARS OF FREE FACTORY SERVICE BY FILLING IN THE APPLICATION NOW.

McIntosh
LABORATORY INC.

2 CHAMBERS STREET, BINGHAMTON, N. Y.

Made in U.S.A.